

FUENTE DE PODER 200W CD 12V A 16.7

WEL-007

WINLED
Más que Iluminación

01 feb 2021

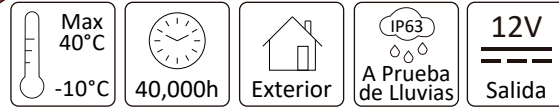

90%
Eficiencia

N/A

ESPECIFICACIONES

 FUENTE DE PODER

 200 WATTS

 90-140V~50/60 Hz

 SALIDA: 12V=== @16.7A

 181x103x50mm

 PESO: 460gr.

 ALUMINIO IMPERMEABLE

 ATENUABLE: NO

 OPERACIÓN: -10 A 40°C

 IP63



Es una balasta o transformador de voltaje, con salida de voltaje constante a 12Vcd, debido a su diseño innovador con cuerpo en aluminio tiene diversas aplicaciones para interiores y exteriores, para sobreponer en muro, a prueba de lluvias IP63 como jardines, patios, estacionamientos, etc.
Compatible con las tiras LED 12Vcd.

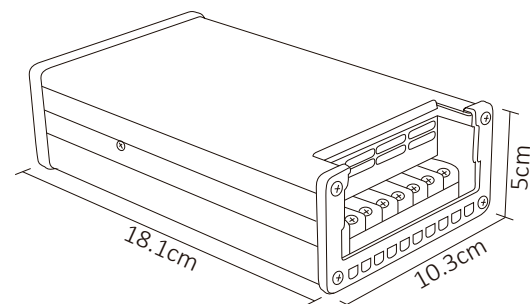
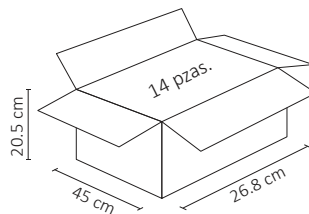

VIDA ÚTIL: 30,000



*Instalar verticalmente verificando que la cachucha este hacia abajo para evitar que las gotas de lluvia lleguen al cableado.

